

# Silent Drawer System

## Modul Box Assembly Instruction

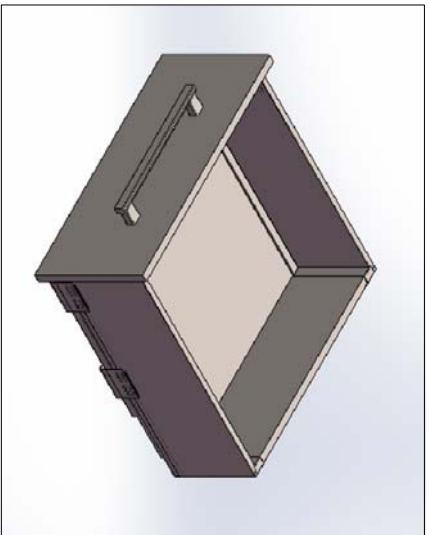

### Special Features:

- Length:270,300,350,400,450,500,550mm.
- The drawer side-board is 120mm high.
- Drawer width can be designed freely with automatic error adjustment.
- Hidden full pulout silencing sliding slid can bear 35kg and enjoys
- excellent stability and quiete and smooth sliding performance.
- Quick installation and dismantle.
- Newly-designed built-in damper is free from reinstallation and ensures soft and smooth drawer movements.

Basic length	Internally usable drawer depth	Minimum installation depth of drawer	Minimum installation height
270mm	244mm	275mm	142mm
300mm	274mm	305mm	142mm
350mm	324mm	355mm	142mm
400mm	374mm	405mm	142mm
450mm	424mm	455mm	142mm
500mm	474mm	505mm	142mm
550mm	524mm	555mm	142mm

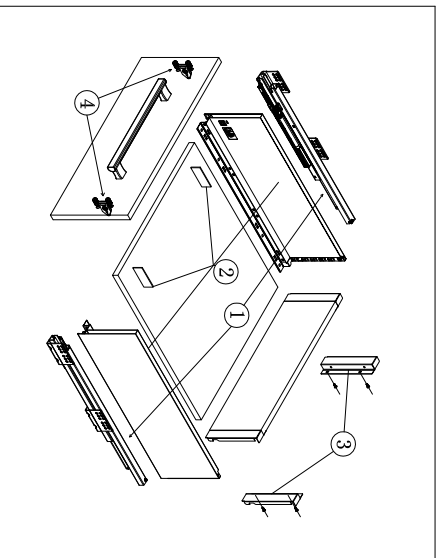

1. Guide	Left/Right	Length
	Left/Right	270mm 300mm 350mm 400mm 450mm 500mm 550mm
2.Drawer Side & Decorative Cap	Left/Right	Length:
	Left/Right	270mm 300mm 350mm 400mm 450mm 500mm 550mm
3.Back connector	Left / Right	
	Left / Right	
4.Front connector	Left / Right	
	Left / Right	

### Runner Installation(mm)

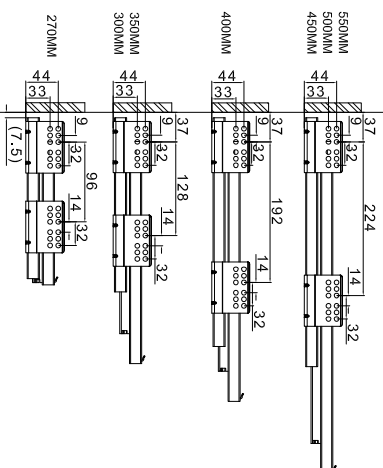

Technology pivot:  
Bottom and Back Panel Measurement  
16MM Density Panel

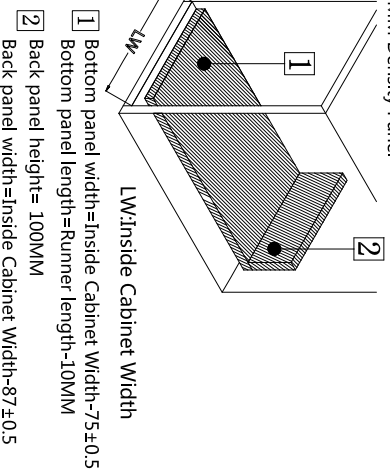

- 1 Bottom panel width=Inside Cabinet Width-75±0.5
- 2 Bottom panel length=Runner length-10MM
- 3 Back panel height= 100MM
- 4 Back panel width=Inside Cabinet Width-87±0.5

### Inside Cabinet Dimension

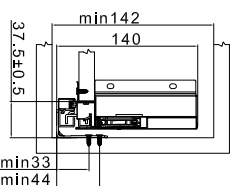

### Front Panel Mounting Positions

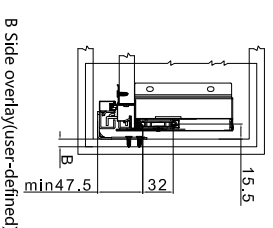

### Front Fixing Brackets Positions

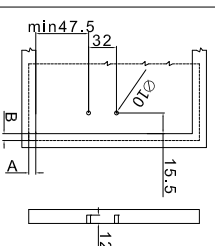

### Back Panel Mounting Positions

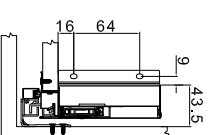

### Front fixing brackets mounting

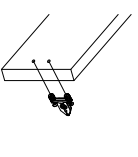

### B Side overlay(user-defined)

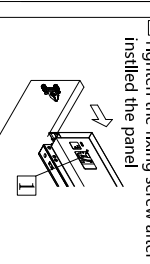

### A B Side overlay(user-defined)



### Back Panel Mounting Positions

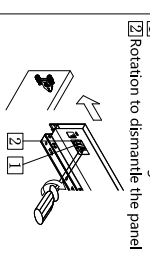

### Front panel height adjustment : ±2mm

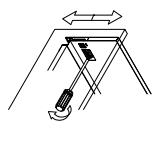

### Front panel side adjustment : right/mm

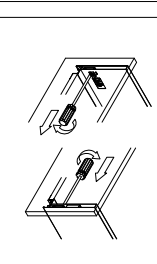

### Front panel side adjustment : left/mm

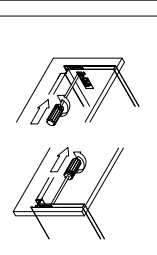

### Mounting the drawer

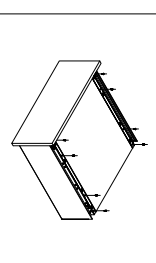
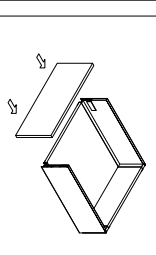
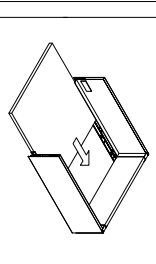
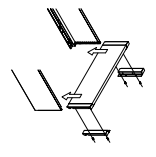

### Installing the drawer

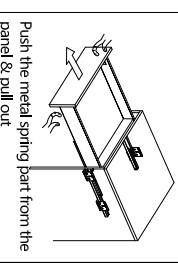
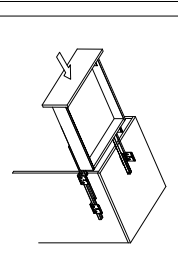
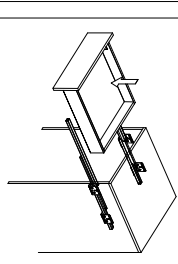
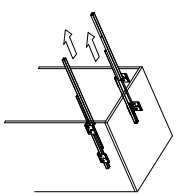

### Function of the damper

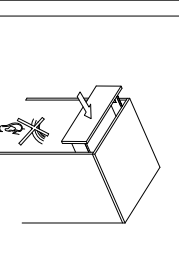
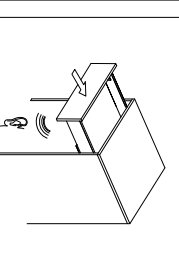
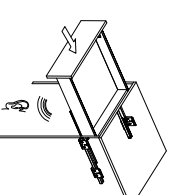

### Removing the drawer

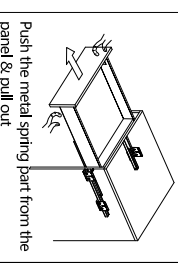

Push the metal spring part from the panel & pull out

- 1 Loosen the fastening screws
- 2 Rotation to dismantle the panel